



**Storage System**  
Quick Start Guide

# TABLE OF CONTENTS

<b>Chapter 1 Wiring</b> .....	<b>6</b>
1.1 Network Wiring.....	6
1.1.1 Single-Controller Storage System.....	6
1.1.2 Dual-Controller Storage System.....	7
1.2 Storage Enclosure Wiring.....	8
<b>Chapter 2 Activation and IP Address Configuration</b> .....	<b>9</b>
2.1 Activation .....	9
2.2 Configure the Controller IP Address.....	9
2.3 Configure Heartbeat.....	10
2.4 Configure Resource IP Address .....	10
<b>Chapter 3 Configuration</b> .....	<b>12</b>
3.1 Time Settings.....	12
3.2 Hybrid SAN Quick Configuration .....	12
3.3 IP SAN Quick Configuration.....	13
3.3.1 Enable iSCSI .....	13
3.3.2 Add IP SAN to Windows Server, DVR, and NVR .....	13

### **Quick Start Guide**

COPYRIGHT ©2018 Hangzhou Hikvision Digital Technology Co., Ltd.

#### **ALL RIGHTS RESERVED.**

Any and all information, including, among others, wordings, pictures, graphs are the properties of Hangzhou Hikvision Digital Technology Co., Ltd. or its subsidiaries (hereinafter referred to be “Hikvision”). This user manual (hereinafter referred to be “the Manual”) cannot be reproduced, changed, translated, or distributed, partially or wholly, by any means, without the prior written permission of Hikvision. Unless otherwise stipulated, Hikvision does not make any warranties, guarantees or representations, express or implied, regarding to the Manual.

#### **About this Manual**

This Manual is applicable to Storage System.

The Manual includes instructions for using and managing the product. Pictures, charts, images and all other information hereinafter are for description and explanation only. The information contained in the Manual is subject to change, without notice, due to firmware updates or other reasons. Please find the latest version in the company website (<http://overseas.hikvision.com/en/>).

Please use this user manual under the guidance of professionals.

#### **Trademarks Acknowledgement**

*HIKVISION* and other Hikvision’s trademarks and logos are the properties of Hikvision in various jurisdictions. Other trademarks and logos mentioned below are the properties of their respective owners.

#### **Legal Disclaimer**

TO THE MAXIMUM EXTENT PERMITTED BY APPLICABLE LAW, THE PRODUCT DESCRIBED, WITH ITS HARDWARE, SOFTWARE AND FIRMWARE, IS PROVIDED “AS IS”, WITH ALL FAULTS AND ERRORS, AND HIKVISION MAKES NO WARRANTIES, EXPRESS OR IMPLIED, INCLUDING WITHOUT LIMITATION, MERCHANTABILITY, SATISFACTORY QUALITY, FITNESS FOR A PARTICULAR PURPOSE, AND NON-INFRINGEMENT OF THIRD PARTY. IN NO EVENT WILL HIKVISION, ITS DIRECTORS, OFFICERS, EMPLOYEES, OR AGENTS BE LIABLE TO YOU FOR ANY SPECIAL, CONSEQUENTIAL, INCIDENTAL, OR INDIRECT DAMAGES, INCLUDING, AMONG OTHERS, DAMAGES FOR LOSS OF BUSINESS PROFITS, BUSINESS INTERRUPTION, OR LOSS OF DATA OR DOCUMENTATION, IN CONNECTION WITH THE USE OF THIS PRODUCT, EVEN IF HIKVISION HAS BEEN ADVISED OF THE POSSIBILITY OF SUCH DAMAGES.

REGARDING TO THE PRODUCT WITH INTERNET ACCESS, THE USE OF PRODUCT SHALL BE WHOLLY AT YOUR OWN RISKS. HIKVISION SHALL NOT TAKE ANY RESPONSIBILITIES FOR ABNORMAL OPERATION, PRIVACY LEAKAGE OR OTHER DAMAGES RESULTING FROM CYBER ATTACK, HACKER ATTACK, VIRUS INSPECTION, OR OTHER INTERNET SECURITY RISKS; HOWEVER, HIKVISION WILL PROVIDE TIMELY TECHNICAL SUPPORT IF REQUIRED.

SURVEILLANCE LAWS VARY BY JURISDICTION. PLEASE CHECK ALL RELEVANT LAWS IN YOUR JURISDICTION BEFORE USING THIS PRODUCT IN ORDER TO ENSURE THAT YOUR USE CONFORMS THE APPLICABLE LAW. HIKVISION SHALL NOT BE LIABLE IN THE EVENT THAT THIS PRODUCT IS USED WITH ILLEGITIMATE PURPOSES.

IN THE EVENT OF ANY CONFLICTS BETWEEN THIS MANUAL AND THE APPLICABLE LAW, THE LATER PREVAILS.

### Regulatory Information

#### FCC Information

**FCC compliance:** This equipment has been tested and found to comply with the limits for a Class A digital device, pursuant to part 15 of the FCC Rules. These limits are designed to provide reasonable protection against harmful interference when the equipment is operated in a commercial environment. This equipment generates, uses, and can radiate radio frequency energy and, if not installed and used in accordance with the instruction manual, may cause harmful interference to radio communications. Operation of this equipment in a residential area is likely to cause harmful interference in which case the user will be required to correct the interference at his own expense.

The device is advised to note that as a seller or a business user (Class A) Devices and intended for use outside the Home area.

#### FCC Conditions

This device complies with part 15 of the FCC Rules. Operation is subject to the following two conditions:

1. This device may not cause harmful interference.
2. This device must accept any interference received, including interference that may cause undesired operation.

#### EU Conformity Statement

 This product and - if applicable - the supplied accessories too are marked with "CE" and comply therefore with the applicable harmonized European standards listed under the EMC Directive 2014/30/EU, the RoHS Directive 2011/65/EU, the LVD Directive 2014/35/EU.

 2012/19/EU (WEEE directive): Products marked with this symbol cannot be disposed of as unsorted municipal waste in the European Union. For proper recycling, return this product to your local supplier upon the purchase of equivalent new equipment, or dispose of it at designated collection points. For more information see: [www.recyclethis.info](http://www.recyclethis.info)

 2006/66/EC (battery directive): This product contains a battery that cannot be disposed of as unsorted municipal waste in the European Union. See the product documentation for specific battery information. The battery is marked with this symbol, which may include lettering to indicate cadmium (Cd), lead (Pb), or mercury (Hg). For proper recycling, return the battery to your supplier or to a designated collection point. For more information see: [www.recyclethis.info](http://www.recyclethis.info)

#### Industry Canada ICES-003 Compliance

This device meets the CAN ICES-3 (A)/NMB-3(A) standards requirements.



## Applicable Models

This manual is applicable to the models listed in the following table.

Series	Model	Type
72 series	DS-A72024R	Single-controller storage system
	DS-A72072R	
AT series	DS-AT1000S	
80 series	DS-A80624S	
81 series	DS-A81016S	
	DS-A81024D	Dual-controller storage system
82 series	DS-A82012D	
	DS-A82024D	

## Symbol Conventions

The symbols that may be found in this document are defined as follows.

Symbol	Description
 <b>NOTE</b>	Provides additional information to emphasize or supplement important points of the main text.
 <b>WARNING</b>	Indicates a potentially hazardous situation, which if not avoided, could result in equipment damage, data loss, performance degradation, or unexpected results.
 <b>DANGER</b>	Indicates a hazard with a high level of risk, which if not avoided, will result in death or serious injury.

## Safety Instructions

- Proper configuration of all passwords and other security settings is the responsibility of the installer and/or end-user.
- In the use of the product, you must be in strict compliance with the electrical safety regulations of the nation and region. Please refer to technical specifications for detailed information.
- Input voltage should meet both the SELV (Safety Extra Low Voltage) and the Limited Power Source with 100~240 VAC or 12 VDC according to the IEC60950-1 standard. Please refer to technical specifications for detailed information.
- Do not connect several devices to one power adapter as adapter overload may cause over-heating or a fire hazard.
- Please make sure that the plug is firmly connected to the power socket.
- If smoke, odor or noise rise from the device, turn off the power at once and unplug the power cable, and then please contact the service center.

## Preventive and Cautionary Tips

Before connecting and operating your device, please be advised of the following tips:

- Ensure unit is installed in a well-ventilated, dust-free environment.
- Unit is designed for indoor use only.
- Keep all liquids away from the device.
- Ensure environmental conditions meet factory specifications.
- Ensure unit is properly secured to a rack or shelf. Major shocks or jolts to the unit as a result of dropping it may cause damage to the sensitive electronics within the unit.
- Use the device in conjunction with an UPS if possible.
- Power down the unit before connecting and disconnecting accessories and peripherals.
- A factory recommended HDD should be used for this device.
- Improper use or replacement of the battery may result in hazard of explosion. Replace with the same or equivalent type only. Dispose of used batteries according to the instructions provided by the battery manufacturer.

# Chapter 1 Wiring

## 1.1 Network Wiring

### **Purpose:**

Before activating your storage system via your computer, build connection between your storage system and computer.

### NOTE

- You shall acknowledge that the use of the product with Internet access might be under network security risks. For avoidance of any network attacks and information leakage, please strengthen your own protection. If the product does not work properly, please contact with your dealer or the nearest service center.
- To ensure the network security of the storage system, we recommend you to have the storage system assessed and maintained termly. You can contact us if you need such service.

### 1.1.1 Single-Controller Storage System

#### **Purpose:**

Follow the steps to build network connection between a single-controller storage system and a computer.

- Network Wiring for Activation and Storage System Management

Connect the management port (MGT) of storage system to the network port of computer.

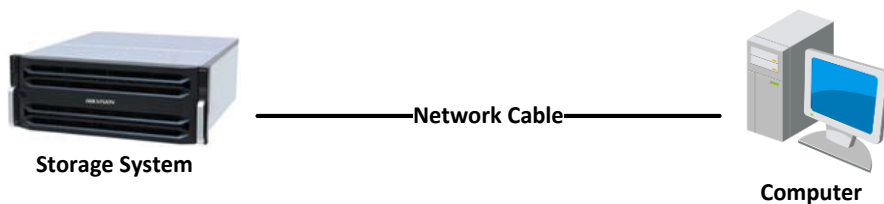

Figure 1-1 Network Wiring for Activation

- Network Wiring for Data Transmission

Connect at least two data ports ( $\begin{matrix} \square 1 \\ \square \square \end{matrix} / \begin{matrix} \square 2 \\ \square \square \end{matrix} / \begin{matrix} \square 3 \\ \square \square \end{matrix}$ ) of storage system to a router or network switch.

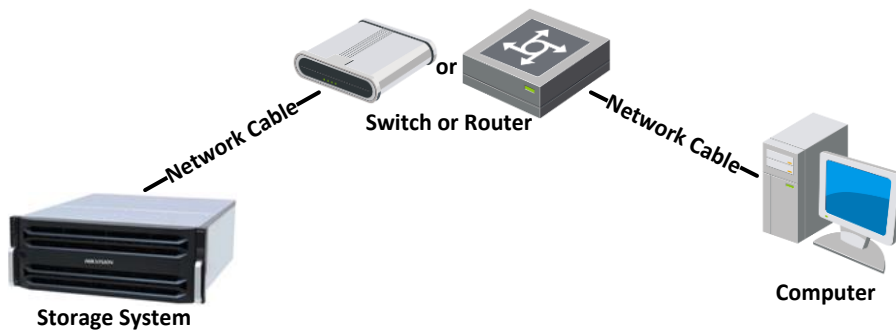

Figure 1-2 Network Wiring

### 1.1.2 Dual-Controller Storage System

**Purpose:**

The following figure shows the cable connection between a dual-controller storage system and a computer.

- Network Wiring for Activation and Storage System Management

Step 1 Connect the management port (MGT) of one controller to the network port of computer.

Step 2 After the activation of the first controller, connect the management port (MGT) of the other controller to the network port of computer.

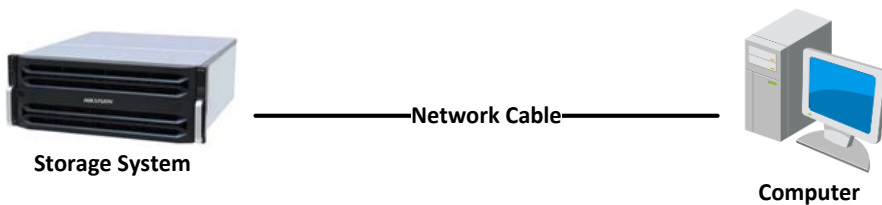

Figure 1-3 Network Wiring for Activation

- Network Wiring for Data Transmission

Connect at least two data ports ( $\begin{matrix} \square 1 \\ \square \square \end{matrix} / \begin{matrix} \square 2 \\ \square \square \end{matrix} / \begin{matrix} \square 3 \\ \square \square \end{matrix}$ ) of each controller to a router or network switch.

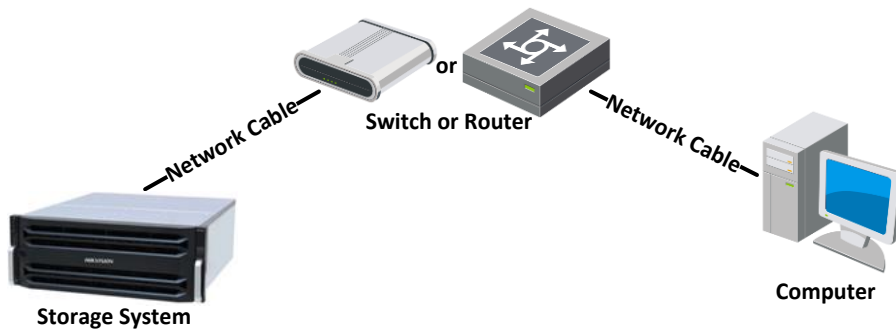

Figure 1-4 Network Wiring



## 1.2 Storage Enclosure Wiring

The SAS extension interfaces of storage enclosure include **SAS 1**, **SAS 2**, and **SAS 3**.

- **SAS 1/SAS 2**: Connect **SAS 1/SAS 2** to the **EXP 1** or **SAS 3** of storage system or **SAS 3** of upper-level storage enclosure.
- **SAS 3**: Connect **SAS 3** to the **SAS 1/2** interface of the lower-level storage enclosure.

 **NOTE**

Both Mini SAS SFF-8644 to SFF-8088 cable and Mini SAS SFF-8644 to SFF-8644 cable are delivered with storage enclosure.

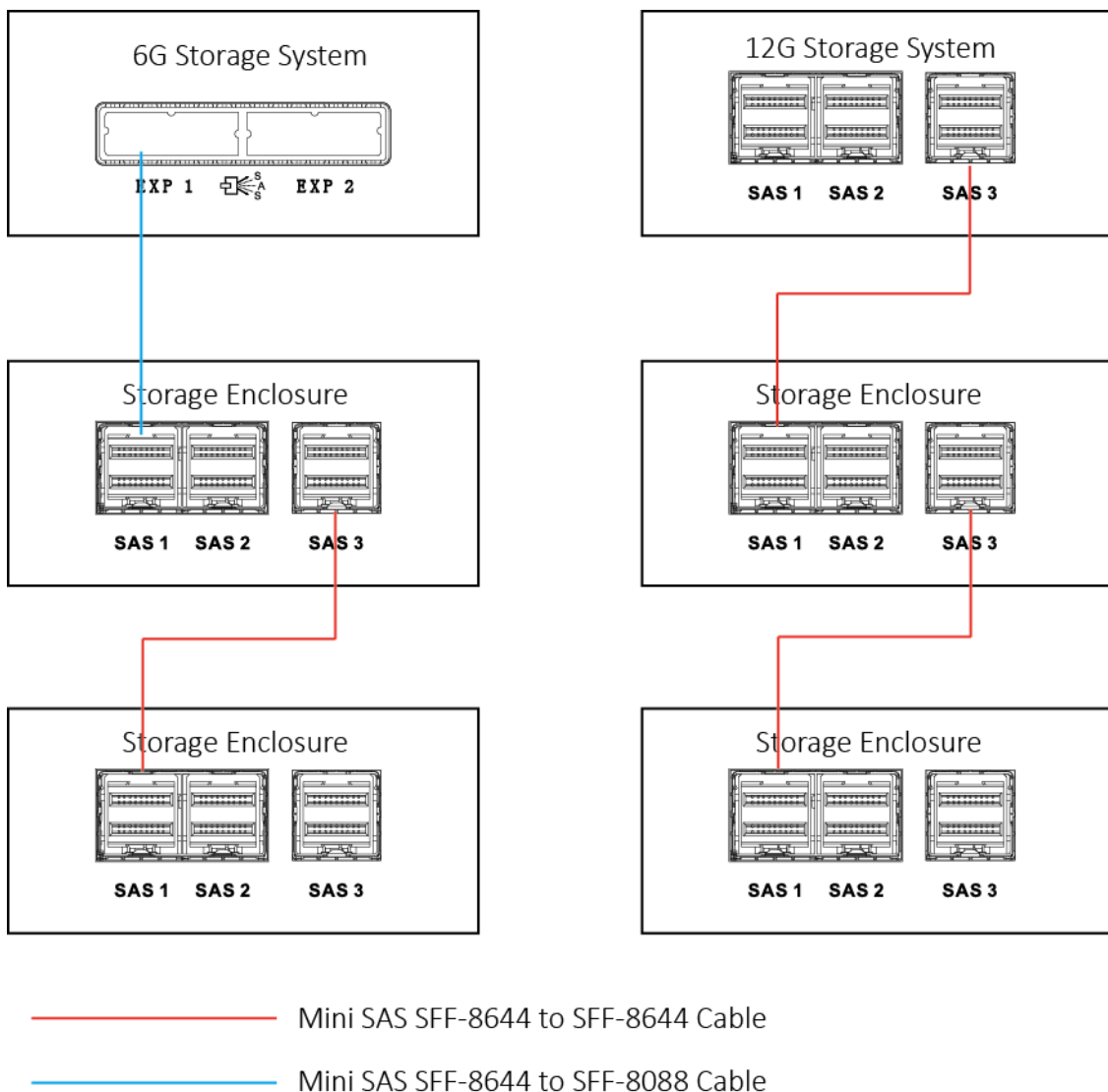

Figure 1-5 Storage Enclosure Wiring

## Chapter 2 Activation and IP Address Configuration

### **Before you start:**

- Build network connection between your storage system and your computer. For details, refer to 1.1 Network Wiring.
- Ensure the network segment of your computer and storage system management port (default: 10.254.254.254) is the same.

### 2.1 Activation

#### **Purpose:**

For the first-time access, you need to activate the storage system by setting an admin password. No operation is allowed before activation.

Step 1 Visit the storage system default IP address (<https://10.254.254.254:2004>) via web browser.

Step 2 Create password for storage system and confirm it.



#### **WARNING**

**STRONG PASSWORD RECOMMENDED**– We highly recommend you create a strong password of your own choosing (using a minimum of 8 characters, including upper case letters, lower case letters, numbers, and special characters) in order to increase the security of your product. And we recommend you reset your password regularly, especially in the high security system, resetting the password monthly or weekly can better protect your product.

---

Step 3 Click **Enter** to activate log into the storage system.

### 2.2 Configure the Controller IP Address

#### **Purpose:**

Data ports are bonded by default. Follow the steps to edit the bonding IP address.

Step 1 Visit the storage system default IP address (<https://10.254.254.254:2004>) via web browser.

Step 2 Go to **System > Network**.

Step 3 Check the bonded data port and click **Modify**.

Step 4 Enter the new IP address.

Step 5 Save the settings.

## 2.3 Configure Heartbeat

**Purpose:**

For dual-controller storage system, you need to configure heartbeat for both controllers.

Step 1 Log into controller A (<https://IP address of controller A:2004>) via web browser.

Step 2 Go to **Cluster**.

Step 3 Click **Auto configure**.

Step 4 Repeat step 1 to 3 for controller B.

Step 5 Click **Test heartbeat** and check logs for cluster heartbeat communication.

## 2.4 Configure Resource IP Address

**Purpose:**

Follow the steps to configure resource IP address for dual-controller storage system. When one of the controller failed, the normal one will take over the tasks and you can log into the normal controller via the resource IP.



**NOTE**

Resource IP can only be configured and enabled in one controller

Step 1 Log into one controller (<https://IP address of one controller:2004>) via web browser.

Step 2 Go to **Cluster**.

Step 3 Select resource **IP Application** as **Hybrid SAN**, select local resource network port, and input **Resource IP** and **Netmask**.

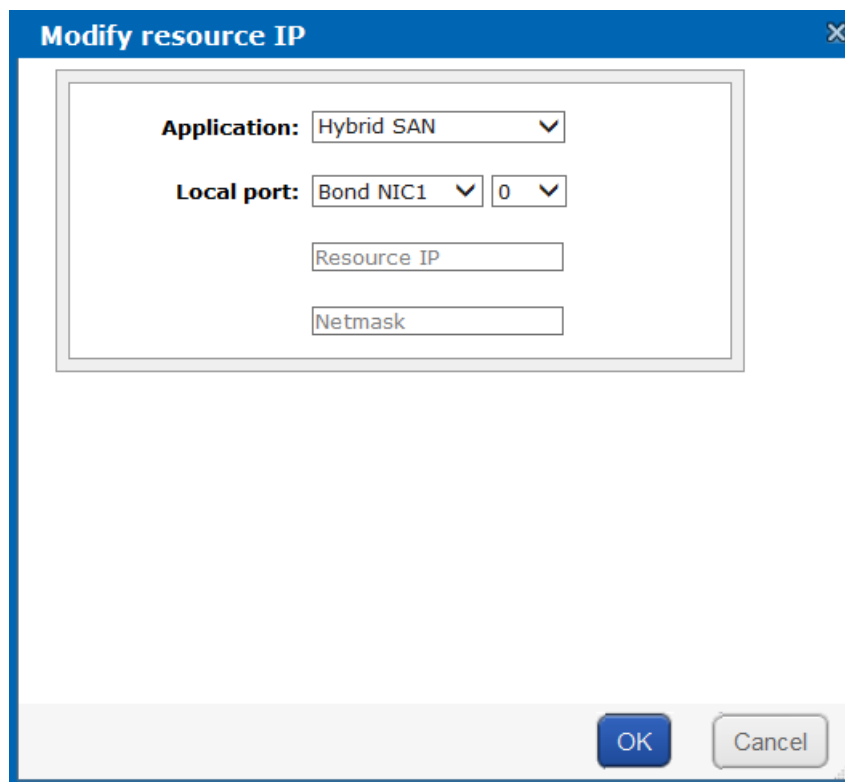

Figure 2-1 Configure Resource IP

Step 4 Save the settings.

## Chapter 3 Configuration

### **Purpose:**

Configure time, Hybrid SAN, and IP SAN parameters.

### 3.1 Time Settings

### **Purpose:**

Set time zone, NTP, and DST for the added storage system.

Step 1 Go to **System > Time Management**.

System -> Time Management		
Time Zone:	(UTC+8:00)'Asia/Beijing'	Modify
DST:	<input type="checkbox"/>	
Date and Time:	Thu Mar 29 2018 02:08:30	Modify
Time Server IP Address:	<input type="text"/>	Adjust
NTP Server:	Disabled	Enabled
Time Synchronization Strategy:	Enabled	Disabled
<b>Time Synchronization Strategy</b>		
Time Server IP Address:	<input type="text"/>	Configure
Synchronization Cycle:	<input type="text"/> min	Delete

Figure 3-1 Time

Step 2 Set **Time Zone**, **Time Server IP Address**, and **DST** as your desires.

Time server IP address should be the IP address of the central server.

Step 3 Click **Save** to save the settings.

### 3.2 Hybrid SAN Quick Configuration

### **Purpose:**

Follow the steps to create a Hybrid SAN quickly.

**Before you start:**

Install HDDs first.

Step 1 Go to **Hybrid SAN > Hybrid SAN**.

Step 2 Click **One-Key Configuration**.

Step 3 Click **OK** to confirm. Quick-setting takes 3 to 15 minutes.

**Result:**

After the successful configuration, the Hybrid SAN status should be **Working**.

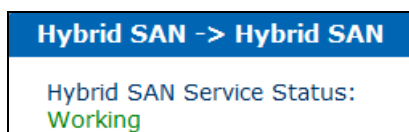

Figure 3-2 Hybrid SAN Status

## 3.3 IP SAN Quick Configuration

### 3.3.1 Enable iSCSI

**Purpose:**

Follow the steps to create an IP SAN quickly.

Step 1 Go to **SAN Management > iSCSI**.

Step 2 Click **One-Key Configuration**.

Step 3 Enter **Client IP**.

**Client IP** is the IP address of DVR, NVR, or window storage server.

Step 4 Click **OK** to save the settings.

### 3.3.2 Add IP SAN to Windows Server, DVR, and NVR

#### Add IP SAN to DVR/NVR

Step 1 Go to NetHDD configuration interface on DVR/NVR.

Step 2 Select **Type** as **IP SAN** and input **NetHDD IP** which is the address of storage system.

Step 3 Click **Search** and select NetHDD Directory.

Custom Add

NetHDD: NetHDD 1

Type: IP SAN

NetHDD IP: 120 . 36 . 2 . 39

NetHDD Directory: iqn.2008-06.storos.1-2

Search

OK Cancel

Figure 3-3 Add IP SAN

Step 4 Click **OK**.

### Add IP SAN in Windows Server

#### ***Before you start:***

For dual-controller storage system, download iSCSI installation package from Microsoft official website into windows server and install it.

Step 1 Go to **Start > Administrative Tool > iSCSI Initiator**.

Step 2 Go to **Discovery** and click **Add Portal**.

Step 3 Input the IP address of IP SAN

Step 4 Click **OK**.

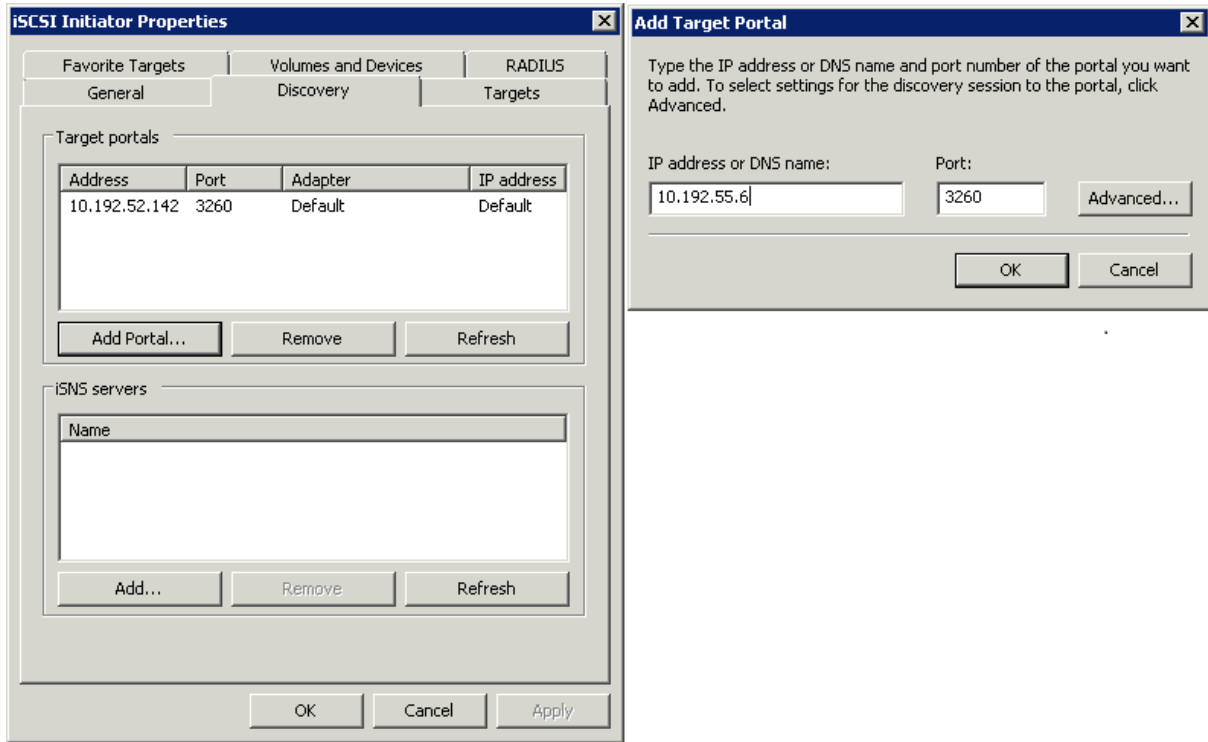

Figure 3-4 Discover Target Portal

Step 5 You can see the targets of IP SAN in the target portals list.

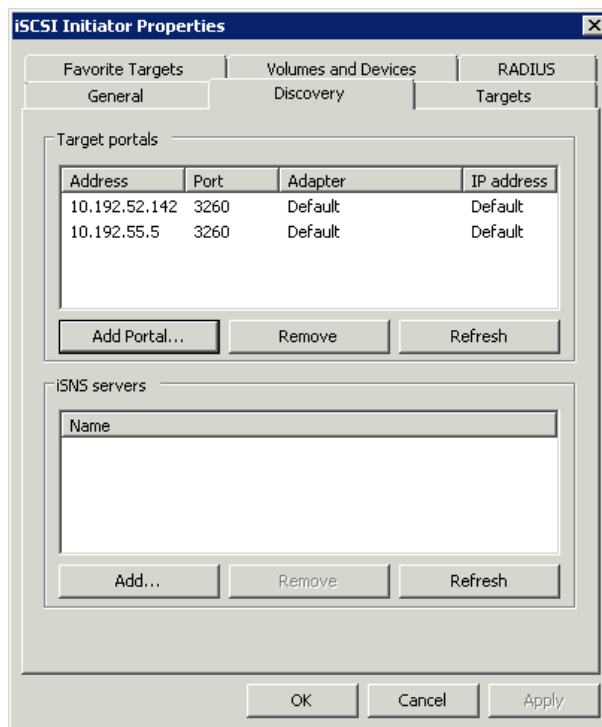

Figure 3-5 Discovery

Step 6 Go to **Targets**.

Step 7 Click the item in Targets list and click **Log on**.



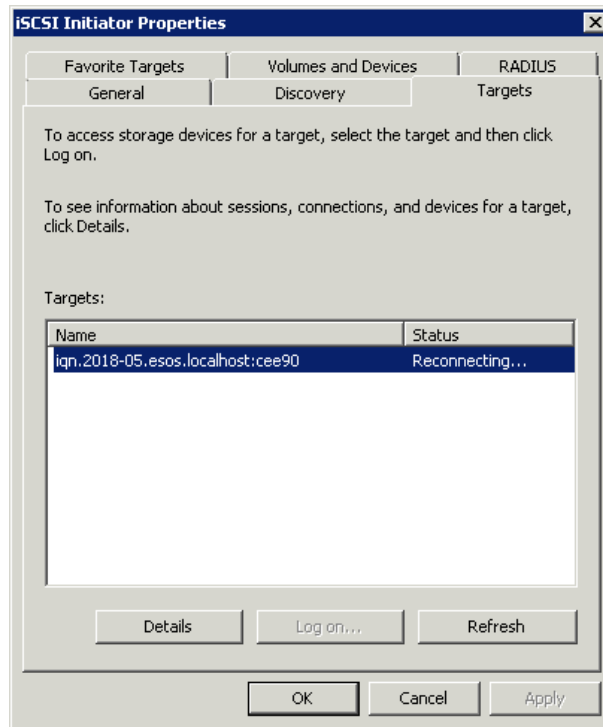

Figure 3-6 Target

Step 8 Go to **Computer Management > Storage > Disk management** in your computer.

Step 9 A new disk will be listed. Initialize the new disk.

### Install MPIO in Windows Server

**Purpose:**

For dual-controller storage system, you need to install MPIO in windows server.

Step 1 Go to **Start > Administrative Tools > Server Manager**.

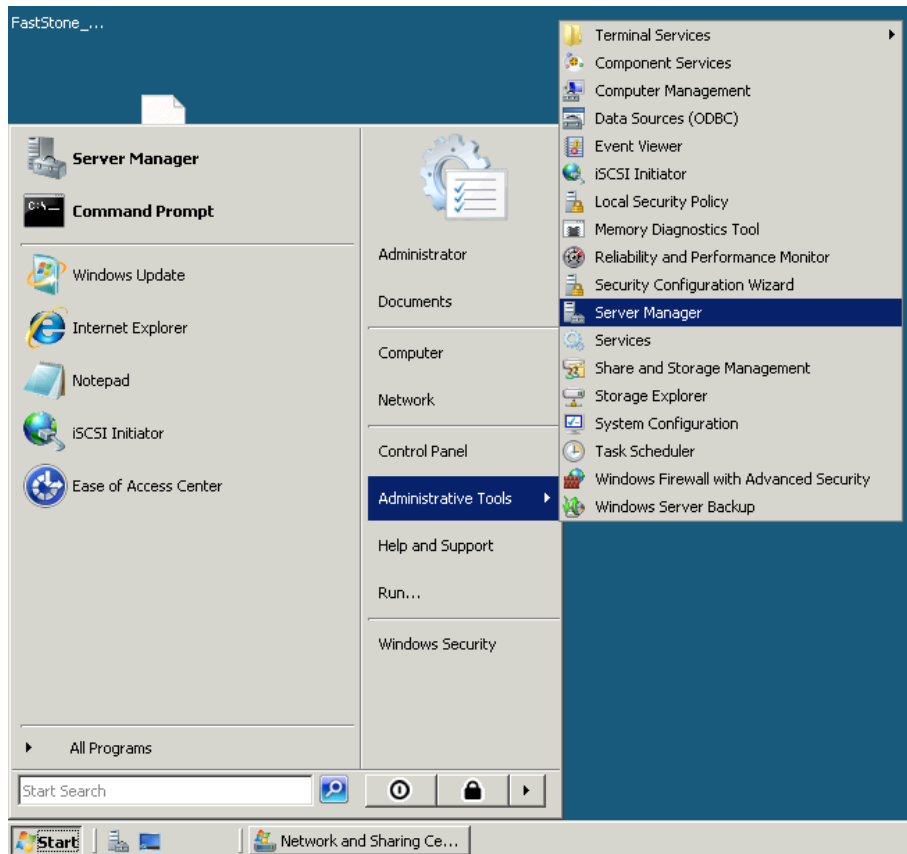

Figure 3-7 Start Menu

Step 2 Select **Features** in the left list.

Step 3 Click **Add Features**.

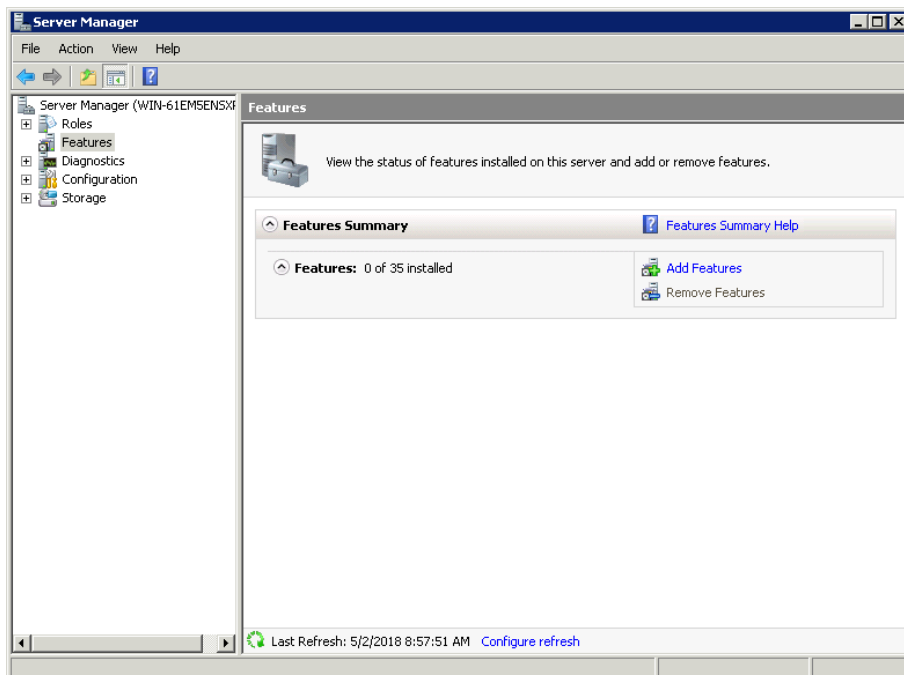

Figure 3-8 Server Manager

Step 4 Check **Multipath I/O** in Features interface and click **Next**.

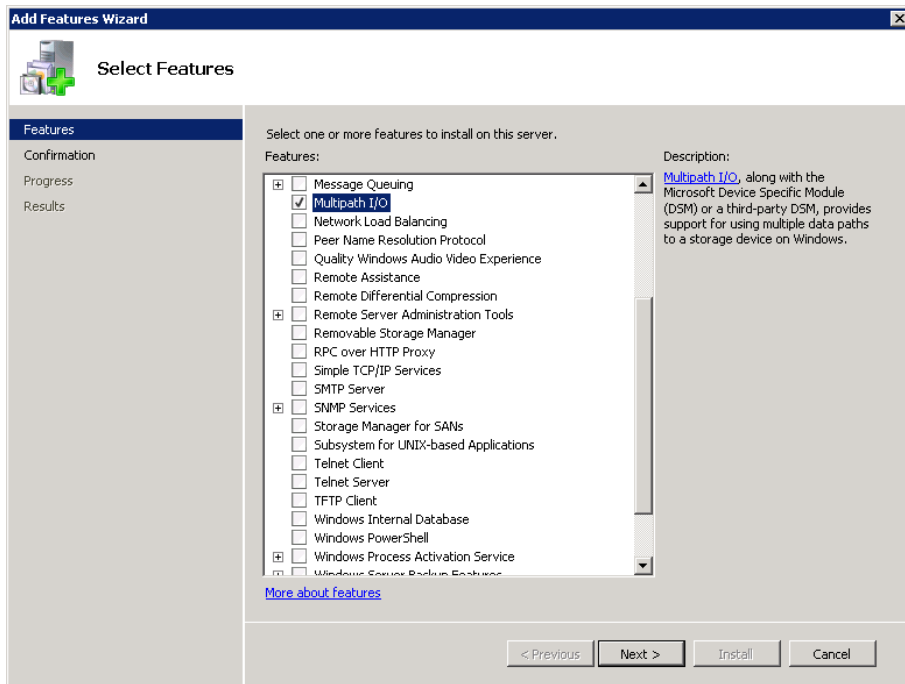

Figure 3-9 Features

Step 5 Click **Install** in Confirmation interface.

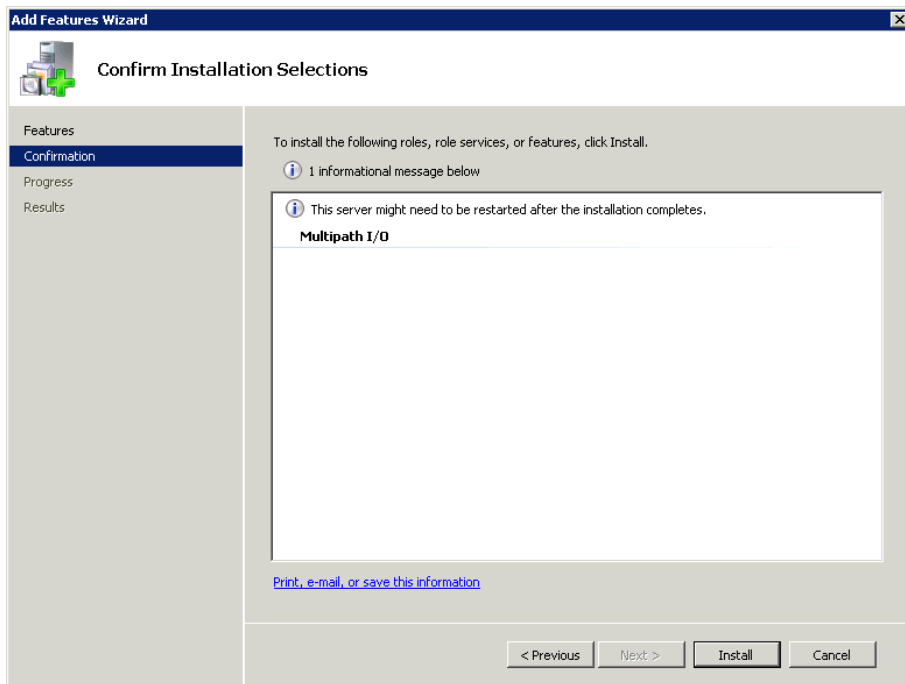

Figure 3-10 Confirmation

Step 6 After successful installation, click **Close** to exit.

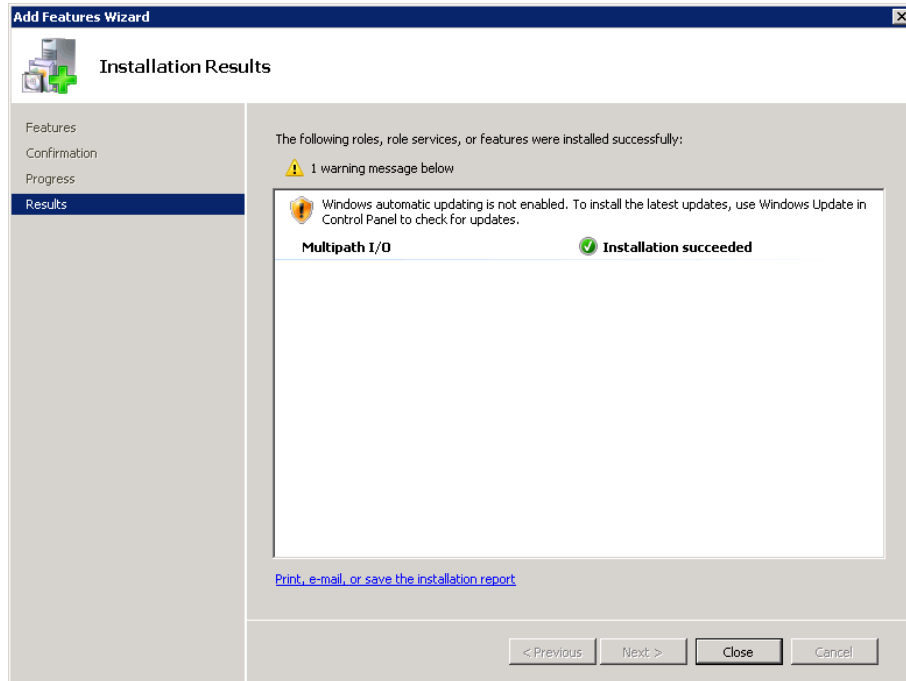
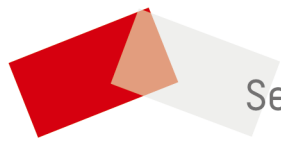

Figure 3-11 Results

Step 7 Go to **Start > Administrative Tool > MPIO > Discover Multi-Paths** tab.

Step 8 Check **Add support for iSCSI devices** and click **Add**.

Step 9 Reboot to activate MPIO.



See Far, Go Further